

## Nominal data

Type	4806 Z	
Phase		1~
Nominal voltage	VAC	115
Frequency	Hz	60
Speed	min <sup>-1</sup>	1800
Power input	W	12.0
Min. ambient temperature	°C	-40
Max. ambient temperature	°C	70
Air flow	m <sup>3</sup> /h	105
Sound power level	B	4.1
Sound pressure level	dB(A)	28

ml = Max. load · me = Max. efficiency · fa = Running at free air · cs = Customer specs · cu = Customer unit  
Subject to alterations

4806 Z

# AC axial compact fan

## Technical features

<b>Mass</b>	0.540 kg
<b>Dimensions</b>	119 x 119 x 38 mm
<b>Material of impeller</b>	Sheet steel, coated in black
<b>Housing material</b>	Die-cast aluminium
<b>Direction of air flow</b>	Exhaust over struts
<b>Direction of rotation</b>	Right, looking at rotor
<b>Bearing</b>	Ball bearings
<b>Lifetime L10 at 40 °C</b>	52500 h
<b>Lifetime L10 at maximum temperature</b>	17500 h
<b>Connection line</b>	2 flat connectors 2.8 x 0.5 mm. Housing with grounding lug for M4 x 8.
<b>Motor protection</b>	Protected from overload using impedance protection
<b>Approval</b>	VDE, CSA, UL, CE
<b>Option</b>	Available with electrical terminals on single strands that are 310 mm in length.

4806 Z

# AC axial compact fan

## Product drawing

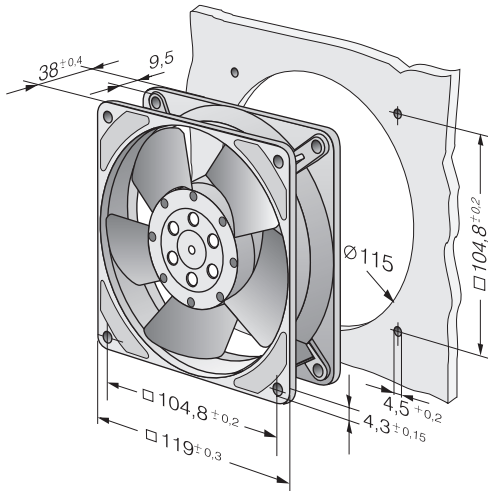

## Charts: Air flow

